



Another  
Smart Solution  
by FROMM

**Airpad**<sup>TM</sup>  
BY FROMM

**SmartFill**  
Scanner & Shooter

1

## AIRPAD Scanner

FROMM's compact void measuring device for optimum void filling

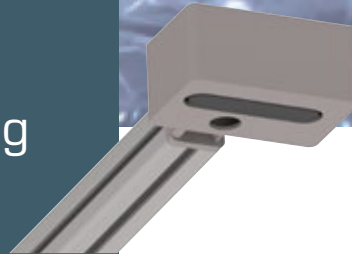

### Always the right number of air cushions

- Calculates the optimum number of air cushions for each carton.
- Ensures the best protection for each carton
- Reduces product damages
- No learning curve for new operators to pack with the best protection
- In combination with the SHOOTER for improved productivity

### Technical specifications

- Power supply: 90 - 240 V, 50 / 60 Hz
- Communication port: RJ485
- Connectors: USB – A, 5-pins, 3-pins
- Weight: 3.5 kg | 11.5 Lbs (without options)
- Speed: up to 20 cartons/min
- Carton size up to 600x500x600 LxWxH (mm) / 24x20x24 (in)
- Item code: 50.100250

### System setup

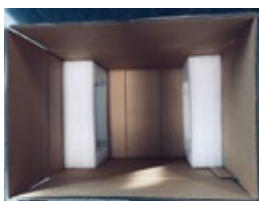

1. Package is detected by the camera and the volume is scanned

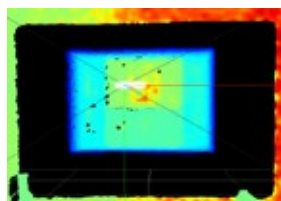

2. Calculate the optimum number of air cushions



3. Digital display for simple and fast process flow

## AIRPAD Shooter

FROMM's compact cutting and dispensing air-cushion device

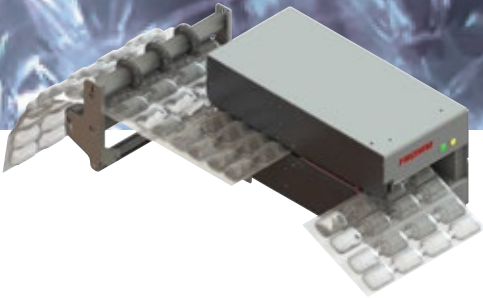

### High speed void filling

- Automatic air cushion separation with high speed transport for quick release, low cycle time (300 ms for a 150mm / 6" cushion)
- Dispense pre-separated cushions at arm's length of the operator for optimum working conditions
- Large touch screen operating panel, wireless for easy integration
- 3 operating modes
- Manual with foot pedal or voice control
- Semi automatic with pre-defined lengths to choose from the touch panel
- Automatic replenishment of a pre-set number of cushions
- In connection with the AIRPAD Scanner

### Technical specifications

- Speed: up to 60 m/min / 200 ft/min
- For films up to 400 mm / 16" wide
- Power supply: 90 - 240 V, 50 / 60 Hz
- Communication ports: RJ485, USB 4.0, Coax
- Monitoring and tracking system for easy maintenance
- Weight: 25.5 kg | 82.0 Lbs (without options)
- Item code: 50.2130

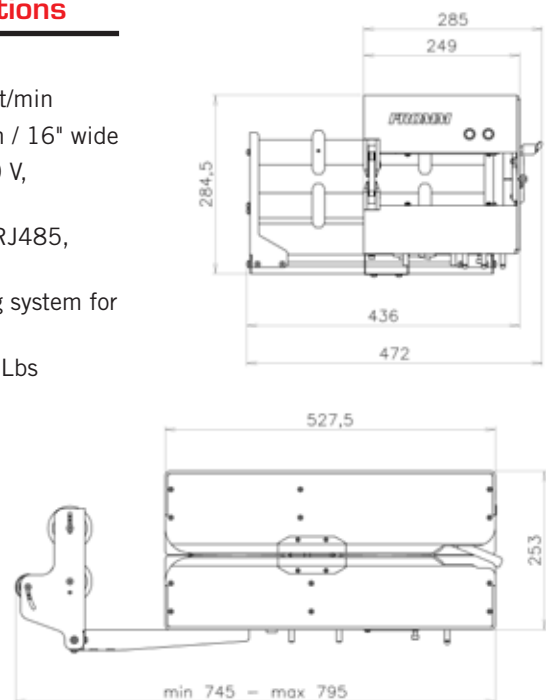

### Setup

#### With Compact bin

- Item code: 50.2131

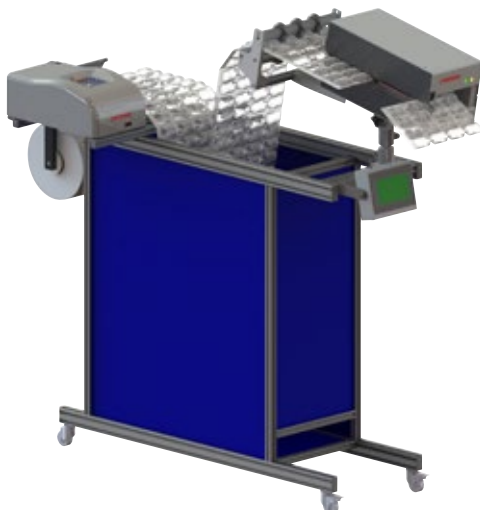

#### With Overhead hopper system

- On demand

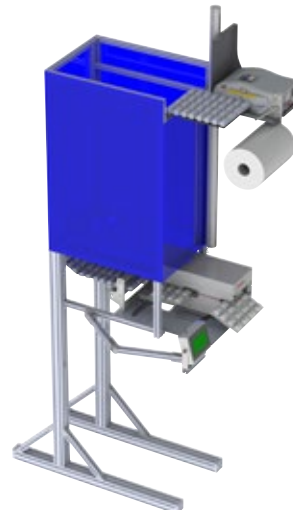



The right number of air cushions  
for an **optimum protection** with  
the best productivity

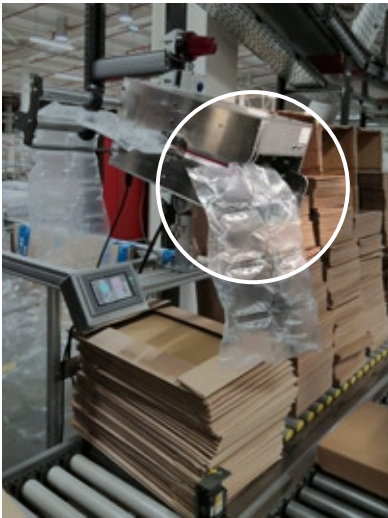

Pre-cut air cushion string ready to be used



Pre-cut air cushion string pulled with one hand

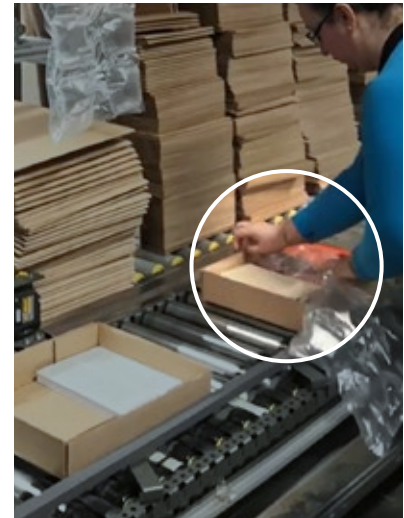

Pre-cut air cushion string placed in the box

### Custom designed solutions

- FROMM is present at all steps of your project, from identification of needs to installation and full maintenance of the line
- FROMM's end-of-the line expertise ensures reliable solutions, increased productivity and optimum ergonomics



**On-time delivery**



**Optimum working conditions**



**Profitable equipment**



**Flexible financing**

**FROMM** | PROTECTING SOLUTIONS

#### FROMM HOLDING AG

Hinterbergstrasse 26  
6312 Steinhausen  
Switzerland

Tel. +41 (0)41 741 57 41  
www.fromm-pack.com

### A 5-STEP PROCESS

- 1 Needs identification**  
Audit questionnaire for accurate description of requirements
- 2 Integration approach**  
2D/3D drawings within 2 weeks Quotation Lead time
- 3 System manufacturing**
- 4 Installation & commissioning**
- 5 Maintenance & Support**